

Instruction Manual

MAGGIE™ **Magnetic Locator**

Manufactured By
Schonstedt Instrument Company
100 Edmond Road
Kearneysville, WV 25430
(304) 725-1050
Fax (304) 725-1095

Made in USA

Preface

The MAGGIE™ Magnetic Locator is a product of over sixty years' experience in producing the world's finest flux-gate magnetometers and magnetic detectors for aerospace, military and civilian applications. The MAGGIE™ incorporates the knowledge obtained from manufacturing under the most rigid quality control standards. The heart of the MAGGIE™ is its patented Schonstedt HeliFlux® magnetic field sensors. These sensors, acknowledged to be the world's finest, make possible the unequalled performance of the locator.

September 2015

Table of Contents

SECTION I: INTRODUCTION.....	3
SECTION II: OPERATING CONTROLS.....	4
ON/OFF, Volume Knob	4
GAIN Knob.....	4
SECTION III: VISUAL AND AUDIBLE INDICATORS.....	5
Gain Level Indicator	5
Battery Level Indicator.....	5
Signal Strength and Polarity Indicator	5
SECTION IV: CONNECTORS AND ACCESSORIES.....	6
Headphone Jack	6
SECTION V: BATTERY REPLACEMENT.....	7
SECTION VI: OPERATING RECOMMENDATIONS & APPLICATION NOTES	8
Search Procedure.....	8
Basic Signal Patterns	9
Strongly Magnetized Markers.....	10
Correct Stake Orientation	11
Locating Manholes, Septic Tanks and Well Casings.....	11
Locating and Tracing Barbed Wire.....	12
Searching Areas along a Chain Link Fence	12
Locating Valve Boxes.....	13
Locating Cast-Iron Pipes.....	14
Locating Steel Drums	15
Locating Ordnance and Weapons.....	15
Other Notes	17
SECTION VII: SPECIFICATIONS	19
SECTION VIII: TECHNICAL SUPPORT.....	19
SECTION IX: WARRANTY/SERVICE INFORMATION.....	19
SECTION X: PARTS DIAGRAM	20

Important Notice

Schonstedt believes the statements contained herein to be accurate and reliable. But their accuracy, reliability, or completeness is not guaranteed.

Schonstedt's only obligation shall be to repair or replace any instrument proved to be defective within seven years of purchase. Schonstedt shall not be responsible for any injury to persons or property, direct or consequential, arising from the use of any instrument.

SECTION I: INTRODUCTION

The MAGGIE™ magnetic locator detects the magnetic field of ferromagnetic objects. It responds to the difference in the magnetic field between two sensors that are spaced approximately 20 inches apart. The MAGGIE™ provides an audio tone along with the convenience of a battery level meter and a gain indication. In addition to these features, the display unit shows the signal polarity and a bar graph representing the relative signal strength. Although most objects can be located using the audio indication alone, simultaneous use of the audio and visual responses will provide additional information to help you pinpoint a target and determine its orientation.

Figure 1 illustrates an application of the locator in which it is used to detect an iron marker of the type used for property line identification. As shown, the magnetic field of the iron marker is stronger at sensor A than it is at sensor B. The audio response of the MAGGIE™ is designed so that the frequency of the audio tone increases as the strength of the magnetic field under detection increases. As a result, the frequency of the audio output is higher than the idling frequency (~ 10 Hz) which exists when the field strength is the same at both sensors. This stronger signal also causes the bar graph display to peak in either the positive or the negative direction when the audio signal is at its highest frequency.

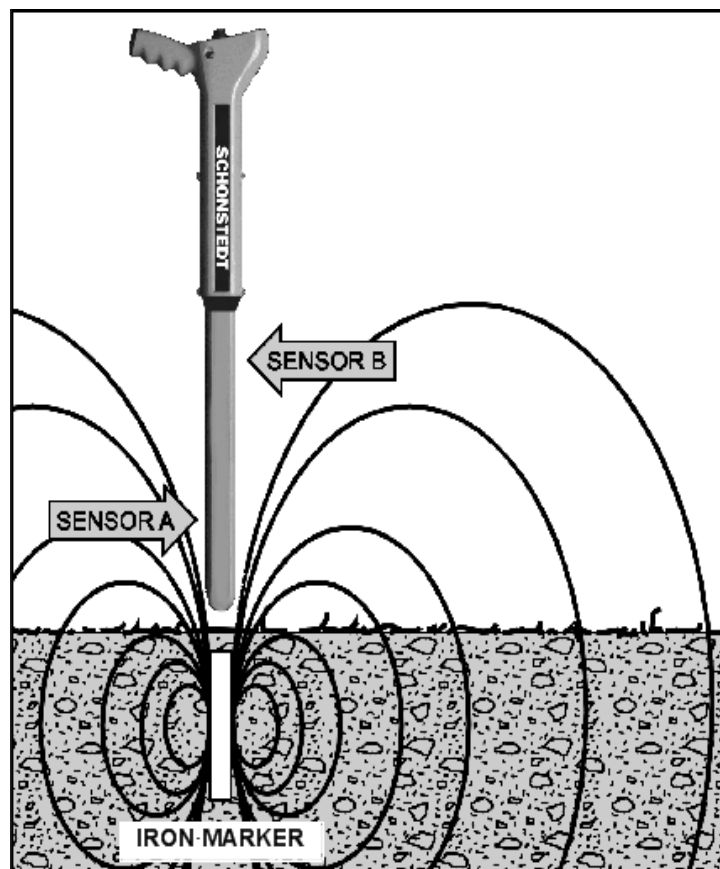

Figure 1. Detecting Magnetic Field of an Iron Marker

SECTION II: OPERATING CONTROLS



Figure 2. MAGGIE™ Face Plate

ON/OFF, Volume Knob: To turn the unit ON pull the on/off button up. To turn it OFF, push it down. The volume of the unit can be increased by turning the knob clockwise.

GAIN Knob: The sensitivity of the unit can be increased (to detect smaller objects at greater depths) by adjusting the gain. The gain is increased by rotating the knob clockwise.

SECTION III: VISUAL AND AUDIBLE INDICATORS

Gain Level Indicator: The gain range is indicated by a 4-segment LCD at each quarter turn as L (Low), M (Medium), H (High) and XH (Extra High). The "Gain" is continuous, and therefore the sensitivity will increase as the knob is rotated. The indicator gives the operator a general idea of the currently selected range of sensitivity.

Battery Level Indicator: The battery level is indicated by a 4-segment LCD indicator, as shown in Figure 3. When all four segments are black the voltage level is between 100% and 75%. As the voltage decreases, the number of black segments decreases. Battery life varies with usage and the ambient temperature. Cold temperatures reduce battery life. Low temperatures may result in only two or three segments being black. This could be temporary and all segments will change to black as the temperature increases.

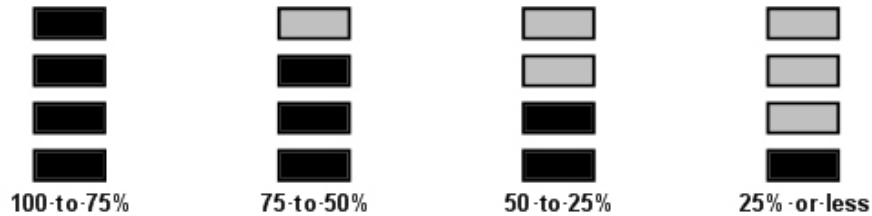

Figure 3. Battery Voltage Status Indications

Signal Strength and Polarity Indicator: The signal strength is shown in a semi-circular bar graph, with more bars indicating a stronger signal, as shown in Figure 4. In addition, the polarity of the signal (+ or -) is also shown on the LCD display, and the bar graph will switch to the + or - side, depending on polarity. The signal strength is also indicated by the frequency of the audio signal, a higher frequency indicates a stronger signal.



Figure 4. Bar graph and Polarity Indications

SECTION IV: CONNECTORS AND ACCESSORIES

Headphone Jack: The headphone jack is located on the side of the unit near the face of the locator. Headphones are optional, and may be purchased from Schonstedt as an accessory. The headphone jack is monaural. Standard stereo headphones available from many sources can be used, but they will produce sound in only one ear. When the headphones are plugged in, the speaker sound will be muted, and the volume knob will control the volume of the headphones.

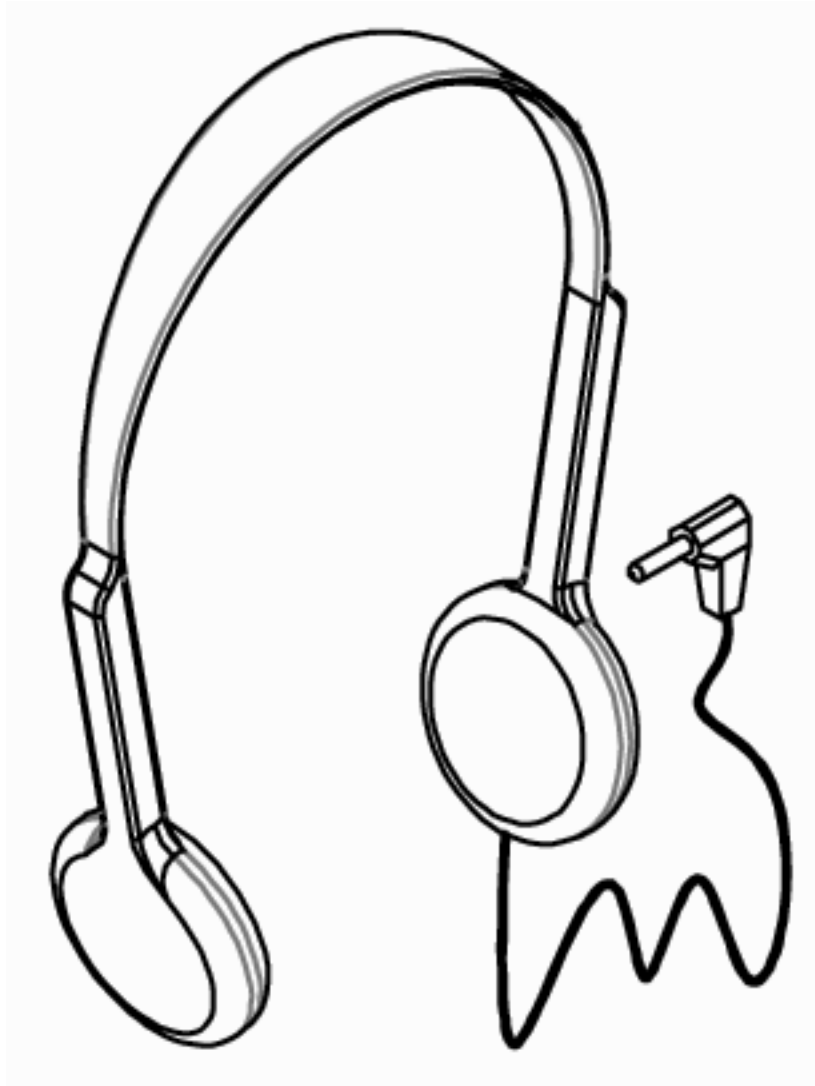

Figure 5. Headphones

SECTION V: BATTERY REPLACEMENT

The MAGGIE™ is powered by one 9-volt disposable battery. The battery is located in the handle of the instrument and can be accessed by turning the screw counterclockwise by hand or with the use of a screwdriver or coin. To remove the battery, simply tilt the unit so that the handle is pointing down, and the battery will slide out. When replacing the battery, look at the outside of the battery door for the proper battery orientation. As a safety measure the unit will not turn on if the battery is not inserted correctly. You should never have to force the battery door closed. If the battery does not seem to be going in all the way, remove the battery, reverse its orientation and then replace it.



Figure 6. View of Battery Door and Compartment

SECTION VI: OPERATION RECOMMENDATIONS AND APPLICATION NOTES

Search Procedure

Set the GAIN control for L and grasp the locator as illustrated in Figure 7. Because the upper sensor is near the locator's handle, wristwatches may produce unwanted changes in the audio signal and in the meter indications, and should be removed. Keep the locator away from your shoes since they might contain magnetic material. To obtain maximum area coverage, sweep the locator from side to side. When the locator comes within range of an iron object, the audio signal will peak and in the bar graph will expand in the positive or negative direction as shown in Figure 8.



Figure 7. Searching With the Locator

When MAGGIE™ is positioned directly over a vertical pipe, the audio indication will peak, and the expanding bar graph will peak at either a positive or negative level.

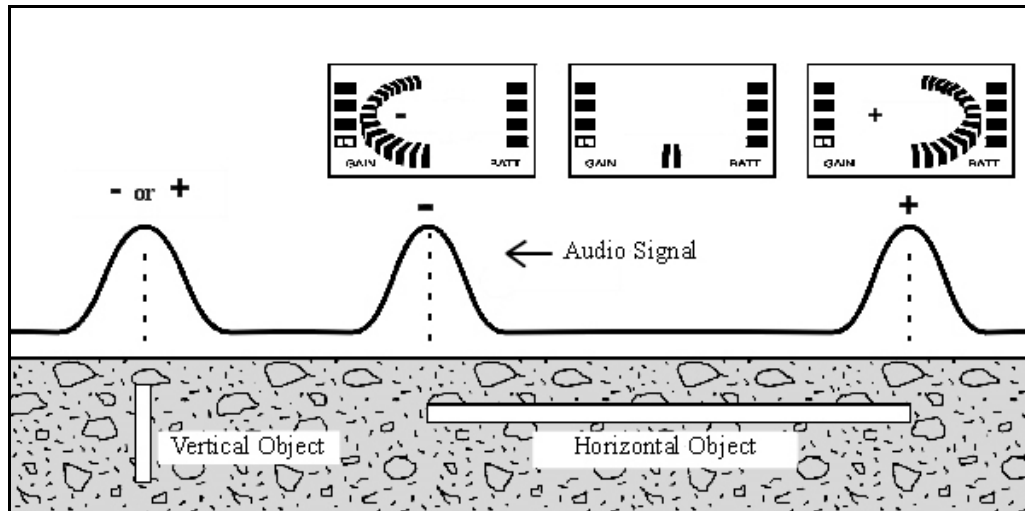

Figure 8. The Meter's Polarity Indications Help to Determine Target Orientation

The audio signal and bar graph indications peak over each end of a horizontal pipe. One end is positive, the other is negative. This will help you to distinguish between two vertical pipes or one horizontal pipe. Usually two vertical pipes buried in close proximity will produce bar graph indications with the same polarity.

Basic Signal Patterns

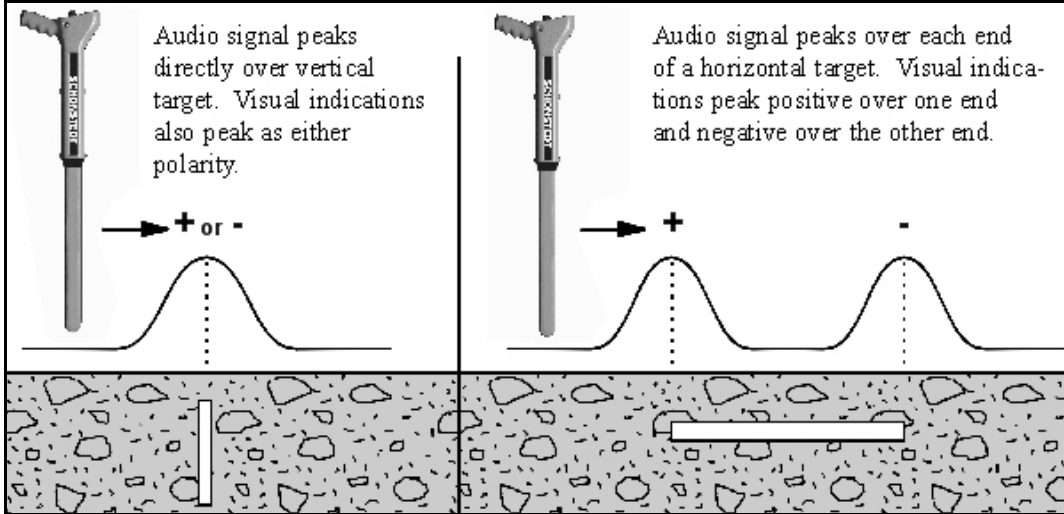

Figure 9. Signals from Vertical and Horizontal Targets

After you have detected the presence of a target, hold the locator vertically and slowly move it back and forth in an "X" pattern while listening to the audio response and observing the bar graph readout. For a given gain setting the number of bars will be greatest when the locator is directly over a vertical target, and over the ends of a horizontal target. The "X" pattern is ideal for pinpointing small objects. A 1-1/4 inch PK nail buried up to 8 inches can be located so precisely with this technique that it can be uncovered using a 1/2 inch star drill.

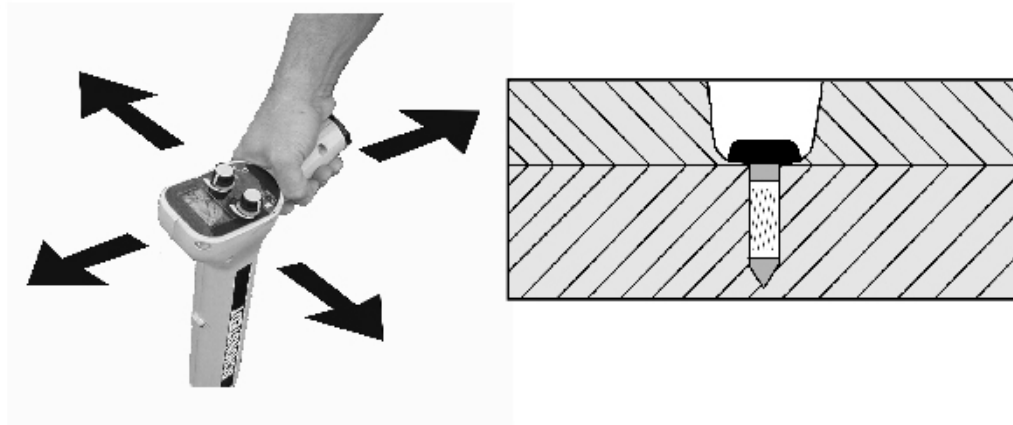

Figure 10. "X" Pattern provides Precision Locating

If you are looking for a corner marker and detect two or three signals in the same general vicinity, decrease the gain setting before you get a shovel. Any signal that disappears when the gain is decreased is probably coming from a smaller target. The signal from a rusty bolt or other small item (see Figure 11) is much weaker than the signal from a larger target such as a 18-inch length of 3/4 rebar which can be located at depths up to 7 feet.

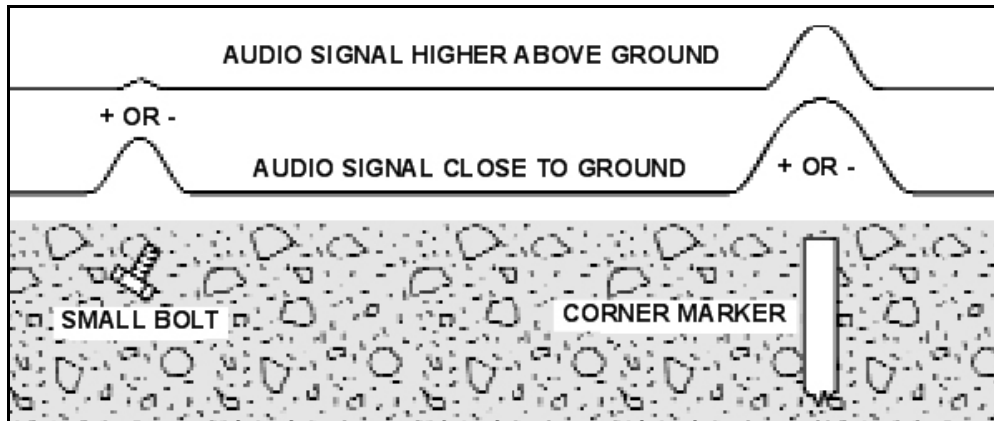

Figure 11. Decreasing gain Eliminates Unwanted Signals

Strongly Magnetized Markers

A strongly magnetized marker at or near the surface provides a weaker indication on both sides of the marker that could be mistaken for the marker.

The heavy line in Figure 12 represents the increase and decrease in the audio and bar graph indications as you move the locator over a marker. Between points **A** and **B** the signals increase slightly and then decrease. Just beyond **B** the signals increase rapidly, peaks directly over the marker and then decreases at point **C**. From **C** to **D** the signals increase and decrease again. So if you do not move the locator completely across the marker you might assume that the weaker indication on either side of the marker is its location.

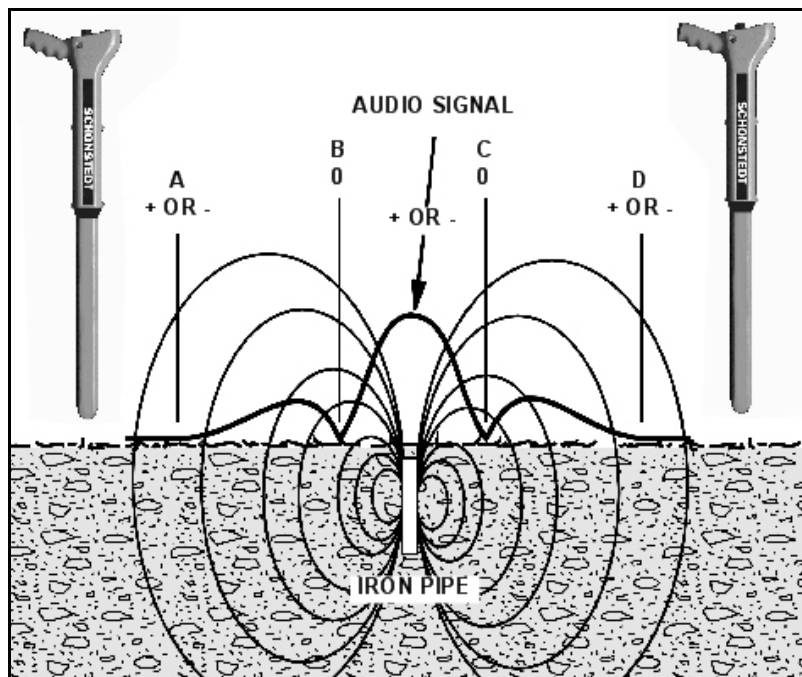

Figure 12. Signal Pattern from a Strongly Magnetized Marker

The two weaker indications occur because the locator is extremely sensitive to the magnetic field components parallel to its long axis. At point B and C the field is perpendicular to the locator so no peak audio or bar graph indications are produced at these points.

Correct Stake Orientation

When Placing Stakes, Correct orientation is Important

For checking purposes, the orientation of the pin relative to the locator is shown in Figure 13. Check the pin with one orientation. Then rotate the pin 180°. The orientation which gives the largest reading is the one that should be used. This reading should be positive in the Northern Hemisphere, and negative in the Southern Hemisphere.

An iron pin has two types of magnetization. One is the magnetization induced by the Earth's magnetic field. The induced magnetization is always downward in the Northern Magnetic Hemisphere and produces a positive output no matter which end of the stake is driven into the ground. The other type of field is the permanent magnetization which is fixed to the pin. For maximum detection, the stake should be driven into the ground such that the permanent magnetization is in the same direction as the induced magnetization.

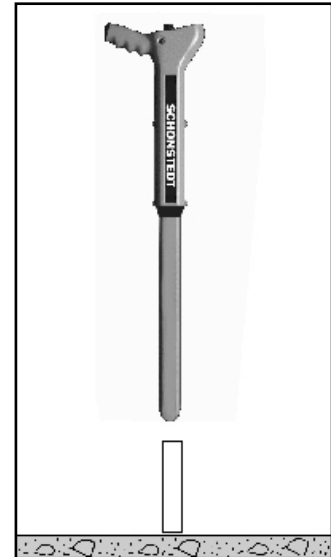

Figure 13. Checking a Stake's Orientation

Locating Manholes, Septic Tanks and Well Casings

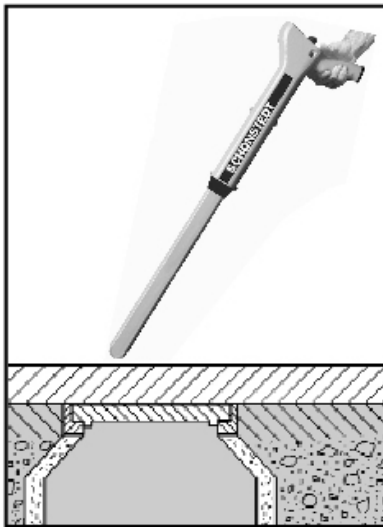

Figure 14. Locating Manhole Covers

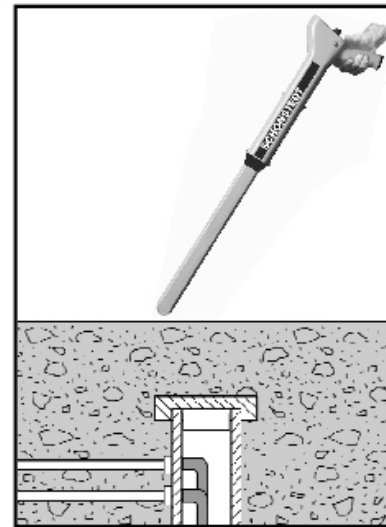

Figure 15. Locating Water Well Casings

The magnetic field is strongest at the edge of a shallow manhole cover. You can easily trace the edges of covers near the surface. Locating depth ranges up to 8 feet. The great length of a well casing provides a strong field at the surface that makes it easy to locate casings buried up to 15 feet deep.

MAGGIE™ can be used to precisely locate the metal handles or reinforcing bars on septic tank covers at depths up to 4 feet.

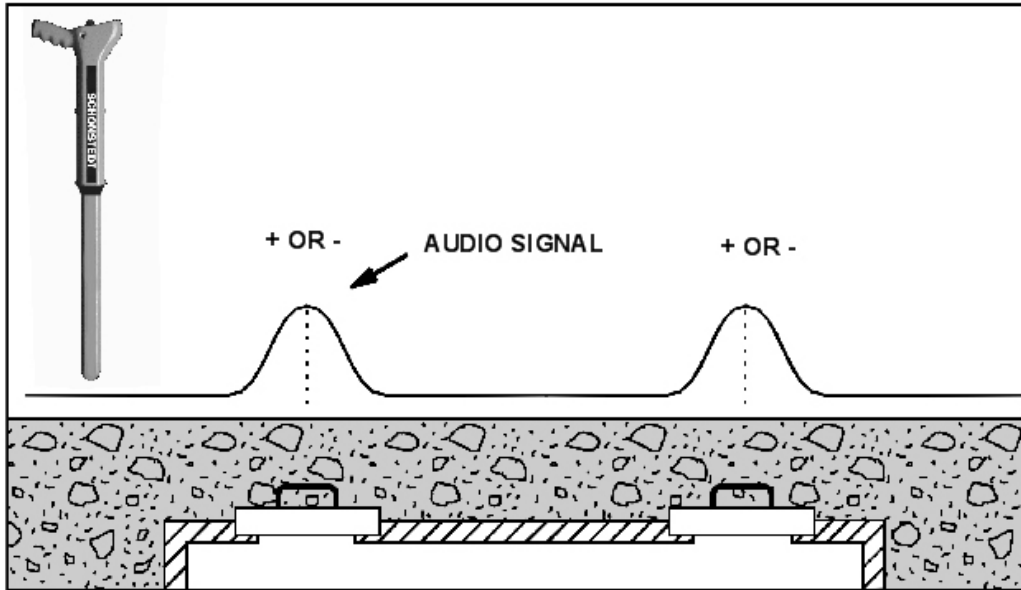

Figure 16. Signal Patterns Provided by Septic Tank Covers

Locating and Tracing Barbed Wire

You can often trace barbed wire (from old fence lines) buried just beneath the surface. Even if the wire is only a trail of rust, it can still be detected near the surface. Tip the locator a little lower than usual - but not parallel with the ground.



Figure 17. Tracing Barbed Wire

Examine trees for bench marks and bits of embedded barbed wire. Hold the locator parallel with the direction of the wire.

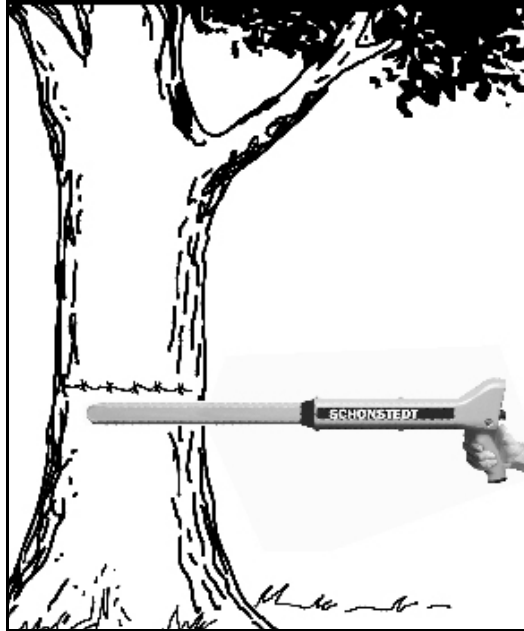

Figure 18. Tracing Barbed Wire from Old Fence Lines

Searching Areas Along a Chain Link Fence

Searching in the vicinity of a chain link fence requires a reduced sensitivity setting and some control over the orientation of the locator. Position the locator horizontally with its long axis perpendicular to the fence as illustrated in Figure 19. This insures that the upper sensor is kept away from the fence.

Perform the search by slowly moving the locator forward along the fence while also moving it to the right and to the left. This technique allows you to search an area several feet wide as you move forward. Listen for an abrupt drop in the signal (as shown by the null in Figure 20) that will occur when the lower sensor, located 1-1/2 inches from the end of the locator, is directly over the stake. Any variation in the position of the locator will produce an abrupt rise in the frequency of the signal.



Figure 19. Searching in the Vicinity of a Chain Link Fence

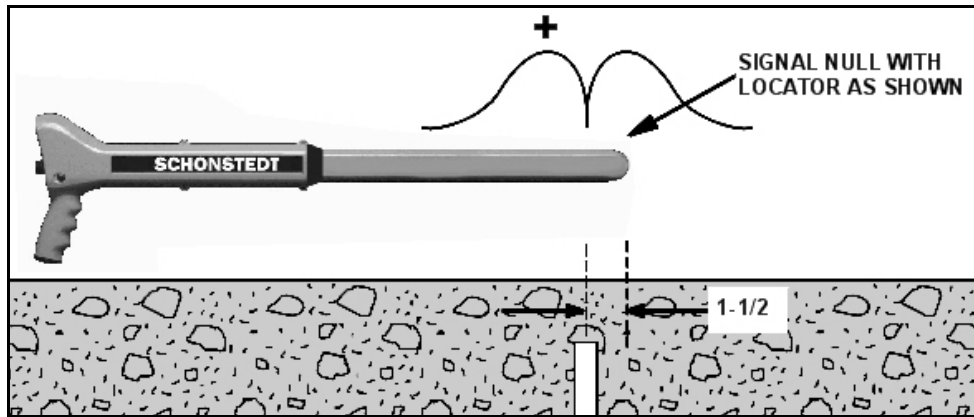

Figure 20. Placement of Locator while Searching along a Chain Link Fence

Locating Valve Boxes

Both the valve and its casing, when iron, provide strong magnetic fields which make them easy to locate. Plastic enclosures containing magnets are easily located at depths of 6 feet or more.

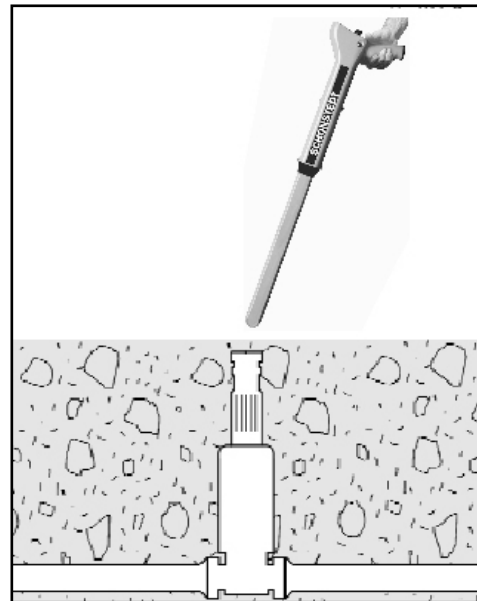

Figure 21. Locating Valve Boxes and Casings

Locating Cast-Iron Pipes

As illustrated in Figure 22, cast-iron pipes produce the strongest magnetic signals at their joints.

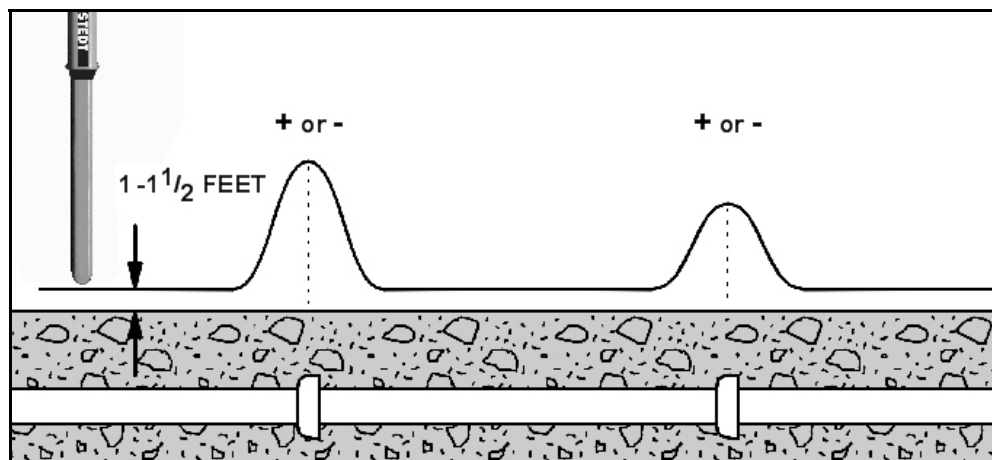

Figure 22. Signal Patterns Provided by Cast-Iron Pipes

The initial search should be performed as follows:

1. Set the Sensitivity control for maximum (XH indication).
2. Hold the locator vertically approximately 1 to 1-1/2 feet above the surface.
3. Walk along without turning or tilting the locator.
4. Mark the locations where the maximum signal levels occur.
5. Return to an area of maximum signal strength and hold the locator several inches above the surface. The sensitivity will probably have to be reduced during this second pass. Four-inch pipes can be located at depths up to 9 feet.

Locating Steel Drums

As shown in Figure 23, MAGGIE's signal pattern will vary depending on the vertical or horizontal orientation of the drum and also how deep it is buried.

A fifty-five gallon drum can be located at depths up to 8 feet.

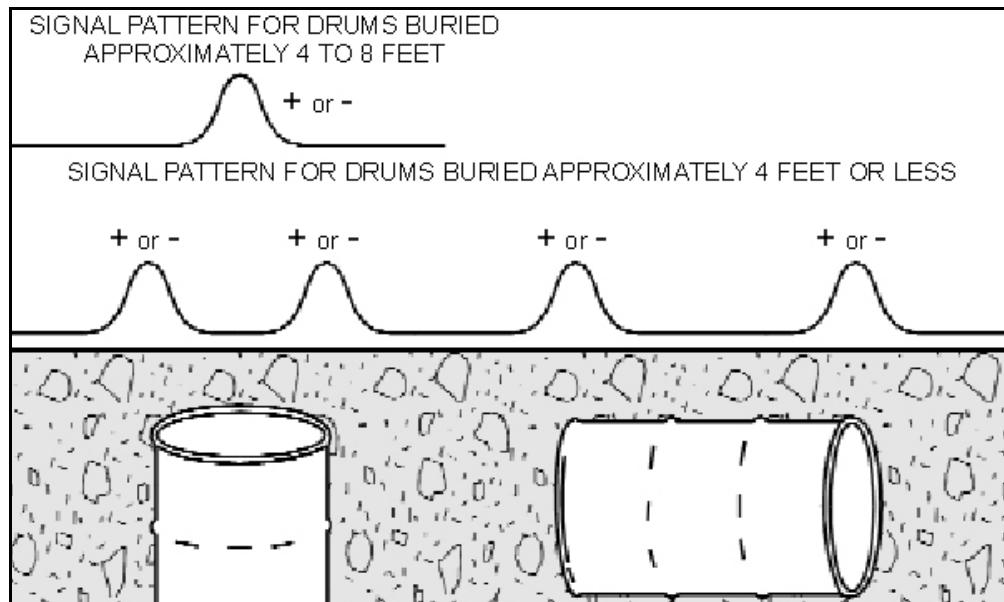
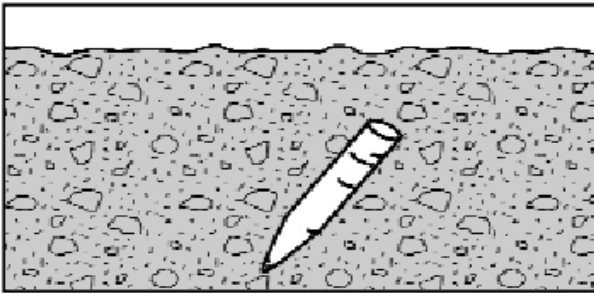
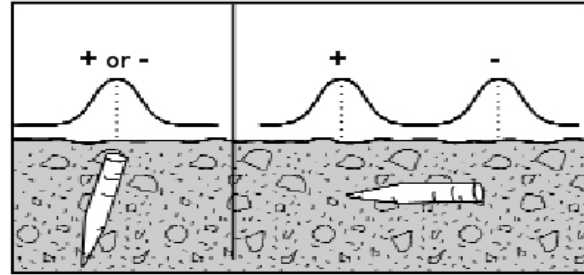

Figure 23. Signal patterns provided by steel drums

Locating Ordnance and Weapons

The versatile, lightweight, cost-effective MAGGIE™ is also designed to aid EOD technicians and law enforcement officers during area search operations.

Basic signal patterns from vertical and horizontal targets help to determine target orientation.



A 175mm projectile can be located up to 4 feet deep.

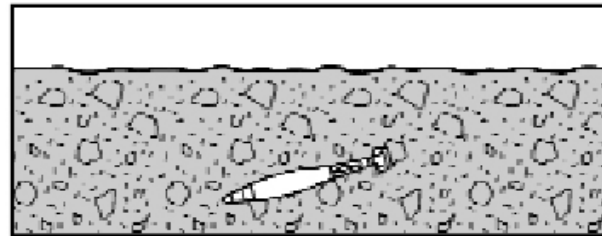

An 81mm mortar can be located up to 12 inches deep.

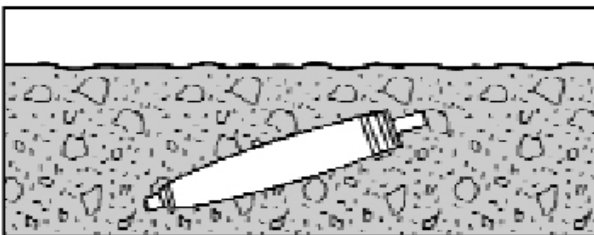

MK81 Low drag bombs can be located up to 7 feet deep.

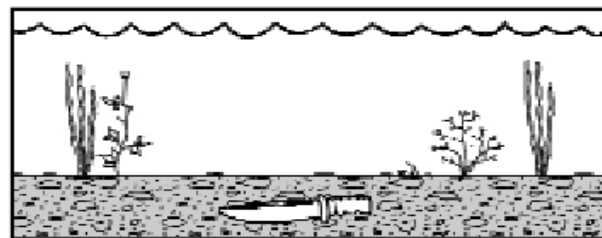

A hunting knife under water can be located in up to 14 inches of silt.

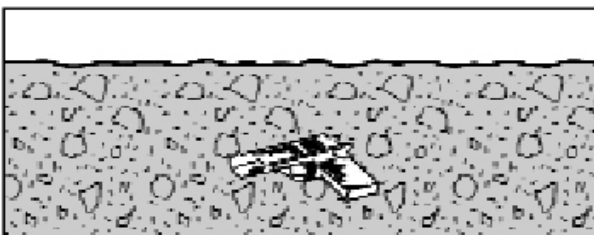

A discarded hand gun can be located up to 12 inches deep.

Other Notes

1. A burbling sound indicates the presence of an energized power line. This will not influence the meter indication unless associated with a magnetic structure.
2. The instrument will not respond to non-ferrous metals such as gold, silver, copper, brass and aluminum.

SECTION VII: SPECIFICATIONS

(Specifications subject to change without notice)

Output	Audio: Signal increases in frequency with gradient field intensity. Idle frequency = 10 Hz. Visual: Expanding bar-graphs indicate polarity (positive or negative) and relative signal strength
Battery Indicator	4-segment LCD
Gain	Continuous control, with range indicated by a 4-segment LCD At each quarter turn, L @ 0-1/4, M @ 1/4-1/2, H @ 1/2-3/4, XH 3/4-Full
Volume	Continuous control
Input Power	Supplied by one 9 V battery
Battery Life	24 Hours (intermittent usage)
Operating Temperature	-13° F to 140° F (-25° C to 60° C)
Water resistant Length	17.5 in (~44 cm)
Overall Length	32.5 in (~83 cm)
Nominal Sensor Spacing	20 in (~50 cm)
Weight	Approximately 2.6 Lbs (1.2 Kg)
Construction	High impact ABS



This device complies with part 15 of the FCC Rules. Operation is subject to the following two conditions: (1) this device may not cause harmful interference, and (2) this device must accept any interference received, including interference that may cause undesired operation.



Application of Council Directive(s):
2004/108/EC

Standard(s) to which Conformity is Declared:
EN 61326:2013. CISPR 11:2009

SECTION VIII: TECHNICAL SUPPORT

Schonstedt offers technical support and sales support. For any reason regarding usage and application please contact our technical support team at 888-367-7014.

SECTION IX: WARRANTY / SERVICE INFORMATION

Limited Warranty:

The Schonstedt Instrument Company (Schonstedt) warrants each product of its manufacture to be free from defects in material and workmanship subject to the following terms and conditions. The warranty is effective for 7 years* (with the return of the Customer Registration Card) after the shipment by Schonstedt to the original purchaser.

Schonstedt's obligation under the warranty is limited to servicing or adjusting any product returned to the factory for this purpose and to replacing any defective part thereof. Such product must be returned by the original purchaser, transportation charges prepaid, with proof in writing, to our satisfaction, of the defect. If the fault has been caused by misuse or abnormal conditions of operation, repairs will be billed at cost. Prior to repair, in this instance, a cost estimate will be submitted. Service or shipping information will be furnished upon notification of the difficulty encountered. Model and serial numbers must be supplied by user. Batteries are specifically excluded under the warranty.

Schonstedt shall not be liable for any injury to persons or property or for any other special or consequential damages sustained or expenses incurred by reason of the use of any Schonstedt product.

** Military & EOD warranty 1 year.*

Service Information:

If your locator needs service, please return it to the factory along with the following information: Name, Address, Telephone, Fax number, Where Purchased, Date, and Description of Trouble(s). An estimate will be provided prior to service work being done.

FOR SERVICE OR REPAIR

Please ship locator to:

Schonstedt Instrument Company
100 Edmond Road
Kearneysville, WV 25430
Attn: Customer Service Dept.

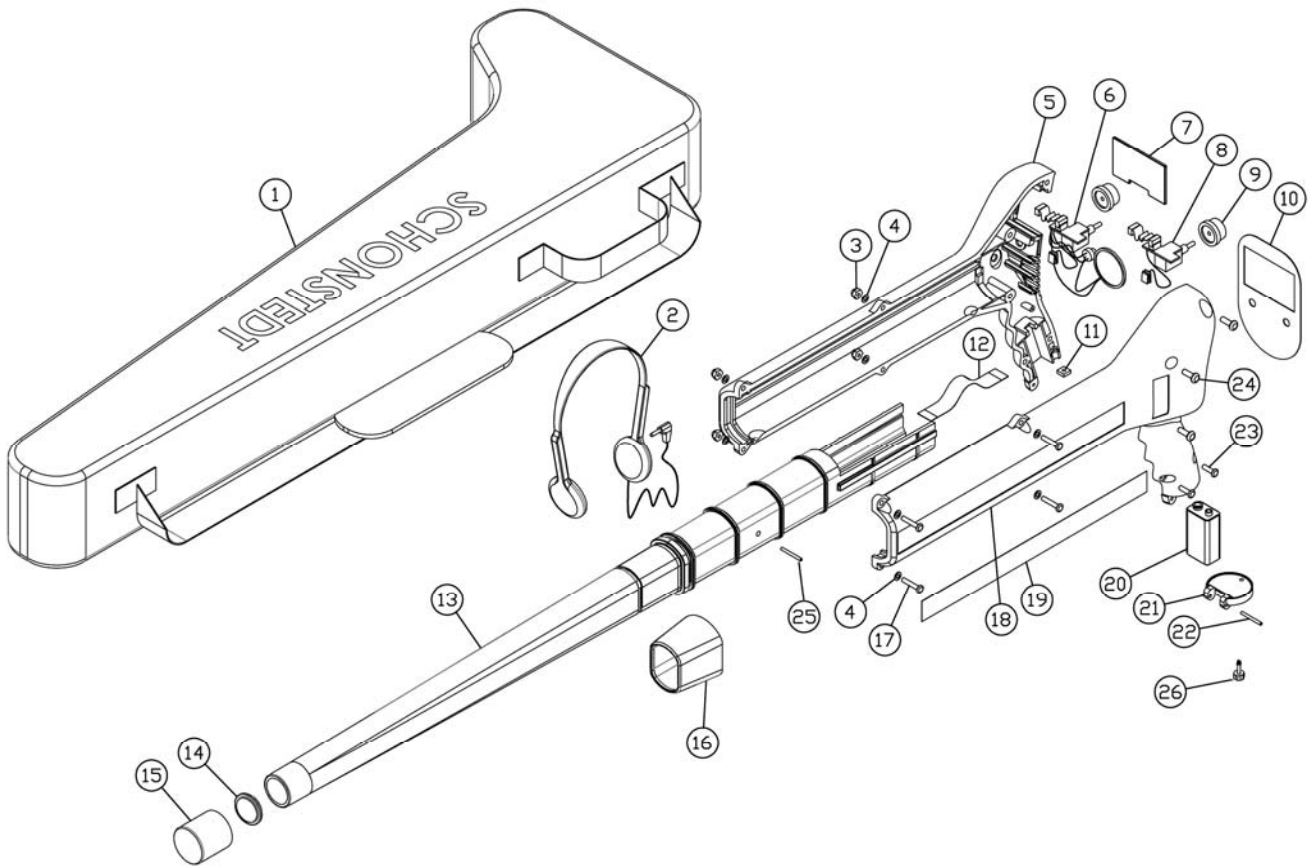

ITEM	PART NO	DESCRIPTION	ITEM	PART NO	DESCRIPTION
1	MA50000	SOFT CASE	14	206750	END CAP, BLACK
2	XT40000	HEADSET (OPTIONAL)	15	208212	CRUTCH TIP, BLACK
3	N51111	NUT, #6-32 CAP	16	MA11308	BOOT
4	WI6P	WASHER, #6 LOCK	17	S51113-NP	SCREW, #6-32 X 3/4
5	XT11100	DISPLAY HOUSING, RIGHT	18	XT11200	DISPLAY HOUSING, LEFT
6	XT11610	VOLUME POT ASSY	19	MA10001	SIDE LABEL, CO / PRODUCT
7	PC11800	DISPLAY LENS	20	B11013	BATTERY, 9V ALKALINE
8	XT11605	GAIN POT ASSY	21	XT13101	BATTERY DOOR ASSY
9	K11105	KNOB, ROUND	22	P23500	ROLL PIN, 3/32
10	MA10003	FACEPLATE	23	S51006	SCREW, #6-32 X 1/2
11	N45000	NUT, #6-32 SQUARE	24	S51008	SCREW, #8-32 X 1/2
12	MA11500	RIBBON CABLE	25	P23504	PIN, 1-7/8" X 1/8" DIA.
13	MA12100	TUBE, SENSOR	26	XT13200	SCREW, CAPTIVE